



STEEL-CRAFT

DOOR PRODUCTS LTD.

THERMOCRAFT

WARNING

These installation instructions are designed for use by professional garage door installers **ONLY**. Certain operations necessary to correctly install this door are **EXTREMELY DANGEROUS** and must be performed **ONLY** by qualified garage door professionals. Failure to properly follow all installation instructions could result in severe injury to the installer or users of the door.

IMPORTANT

It is very important to read and understand these instructions before beginning the installation. It is very important to stop and heed all "**WARNINGS**" and "**CAUTIONS**" contained in these instructions at each step before proceeding.

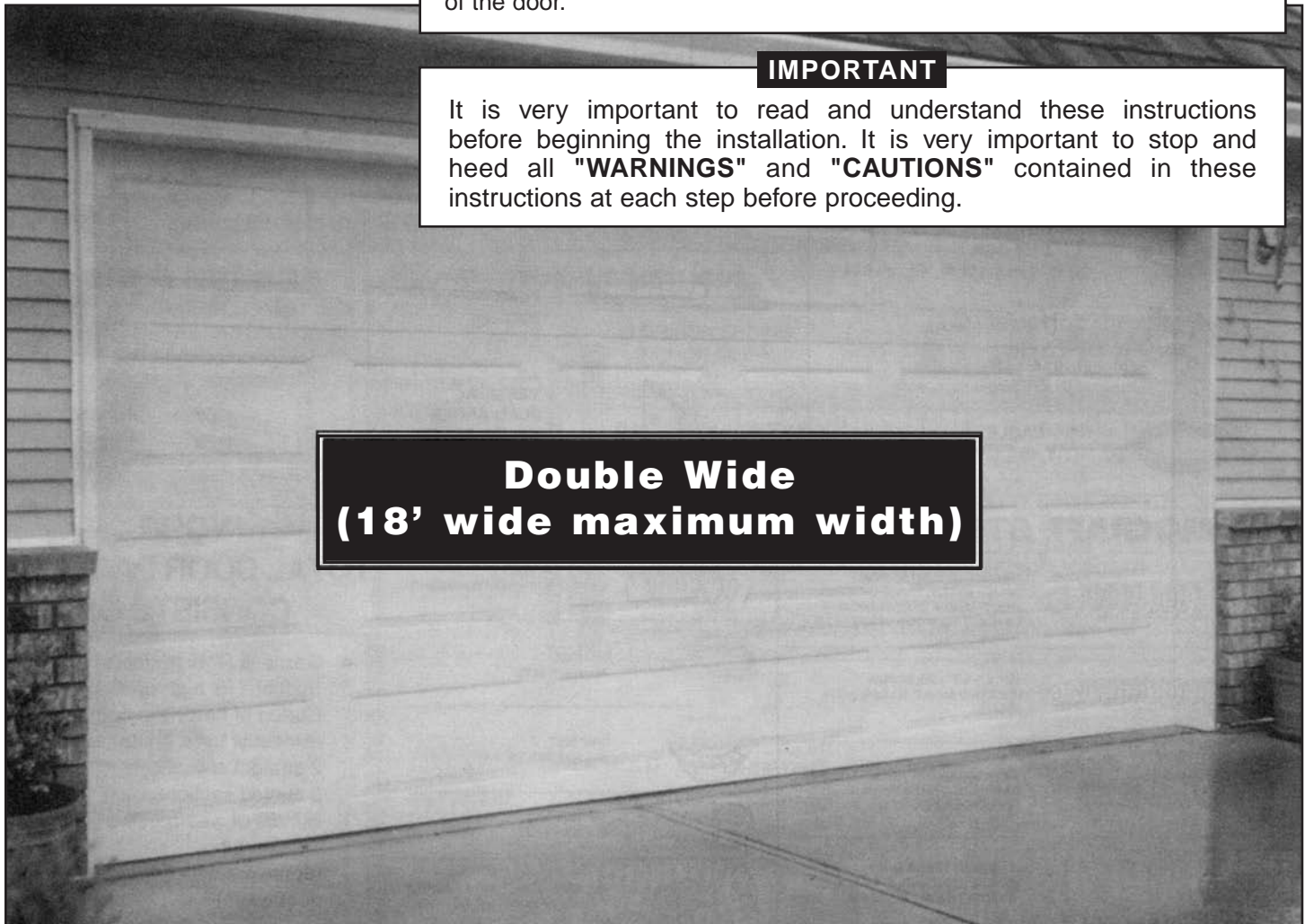

**Double Wide
(18' wide maximum width)**

INSTALLATION INSTRUCTIONS

For Standard Installation 12" Head Room Required

- THERMOCRAFT T12
- THERMOCRAFT T16









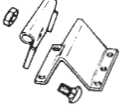

CONGRATULATIONS

You have purchased the best door and hardware that money can buy. Steel-Craft Door Products Ltd. has earned an enviable reputation nation-wide as a "state of the art" garage door manufacturer. The Steel-Craft door that you have purchased will provide year after year of smooth, reliable, trouble-free service provided that it is installed and maintained according to the following instructions.

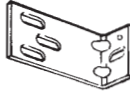
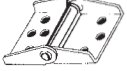

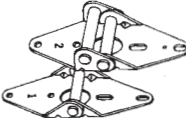

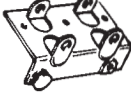
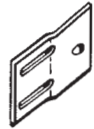
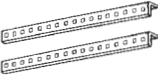



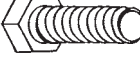

GETTING STARTED

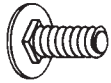
Open the hardware box and familiarize yourself with the components you will be assembling. Some of the items shown here may not be part of the package that you have purchased. Cable drums, end bearing plates, torsion springs, bottom brackets and curved tracks are handed (RH or LH). All other components are universal.

HARDWARE BOX COMPONENTS

 <p>STEEL OR NYLON ROLLERS 7" HIGH DOOR (QTY. 10) 8" HIGH DOOR (QTY. 12)</p>	 <p>CENTRE BEARING PLATE (QTY. 1)</p>	 <p>HORIZONTAL HEAD ANGLE (QTY. 2)</p>
 <p>TOP FIXTURE (QTY. 2)</p>	 <p>END BEARING PLATE (QTY. 2) 1-RH & 1-LH (LH SHOWN)</p>	 <p>TRACK BRACKET (QTY. 4)</p>
 <p>CENTRE HINGE 7" HIGH DOOR (QTY. 6) 8" HIGH DOOR (QTY. 8)</p>	 <p>CABLE DRUM (QTY. 2) 1-RH & 1-LH</p>	 <p>TORSION SPRING (QTY. 2) 1-RH & 1-LH</p>
 <p>END HINGE 7" HIGH DOOR (QTY. 2) each of #1, #2 & #3 8" HIGH DOOR (QTY. 2) each of #1, #2, #3 & #4</p>	 <p>VERTICAL FLAG ANGLE (QTY. 2)</p>	 <p>BAG OF BOLTS AND SCREWS (QTY. 1)</p>
 <p>BOTTOM BRACKET (QTY. 2) 1-RH & 1-LH (RH SHOWN)</p>	 <p>VERTICAL FLAG ANGLE SPLICE PLATE (QTY. 2)</p>	 <p>HANGING ANGLE (QTY. 4)</p>
 <p>LIFT CABLE (QTY. 2)</p>		

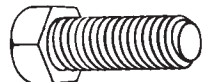
THERMOCRAFT STEEL SECTIONAL DOOR FASTENERS

 <p>5/16" X 1-1/2" LAG SCREW SPLICE ANGLE, TRACK BRACKET, WOOD JAMB & SPRING ANCHOR BRACKET TO WOOD SPRING PAD.</p>	 <p>5/16" X 3/4" BOLT CEILING SUPPORT TO HANGING ANGLE.</p>
 <p>1/4" X 1-1/2" LAG SCREW PUNCHED ANGLE TO CEILING JOISTS.</p>	 <p>3/8" NUT ALL 3/8" BOLTS.</p>
 <p>1/4" X 1/2" SHORT NECK CARRIAGE BOLT ROLLER HOLDER TO TOP FIXTURE.</p>	 <p>5/16" NUT ALL 5/16" BOLTS</p>
 <p>KNURLED TRACK BOLT FLAG & HEAD ANGLE, TRACK BRACKETS & SPLICE PLATE.</p>	 <p>1/4" NUT ALL 1/4" BOLTS.</p>
 <p>3/8" SET SCREW CABLE DRUM AND SPRING WINDING CONE TO TORSION TUBE (SHAFT).</p>	 <p>#10 X 5/8" SHEET METAL SCREW SIDE WEATHERSTRIP TO JAMB</p>
 <p>3/8" X 1" OR 1-1/2" BOLT SPRING TO CENTRE BEARING PLATE.</p>	 <p>SPAN BRACE CLIPS SPAN BRACE</p>

YOUR TOTAL DOOR PACKAGE CONSISTS OF:

- 4 Sections (7' high doors)
- 5 Sections (8" high doors)
- 1 Carton of hardware components
- 1 Bundle of track containing:
2 straight sections
2 curved sections
- 1 Bundle of weatherstrip (optional)
- 1 Torsion tube
(approximately 6" longer than
door width)

SPAN BRACE OPTIONS

- 12' wide door maximum 1
- 14' wide door maximum 1
- 16' wide door maximum 1
- 18' wide door maximum 1

START BY READING THESE IMPORTANT SAFETY RULES



This safety alert symbol means Caution, Personal Safety or Property Damage Instruction. Read these instructions carefully. This garage door is designed and tested to offer safe, reliable service provided that it is installed in strict accordance with these safety instructions. Failure to comply with the safety instructions may result in serious personal injury or property damage.



When using a power tool, follow the tool manufacturer's safety guidelines. Ensure all power tool cords are in good repair and fitted with three-pin (grounded) plugs.



Ensure your work area is clean and uncluttered. Do not allow dirt or sand to enter the rollers or headshaft bearings.



Ladders and scaffolding must be in good repair and secured when in use.



Torsion springs can be extremely dangerous. Use the proper winding rods when working on the springs, (see accessories page 12) do not use makeshift devices such as screwdrivers, ratchet handles, etc. Refer to page (8) for detailed instructions.



Do not wear rings, watches or loose clothing when installing or servicing an overhead door.



Read this owner manual from cover to cover to familiarize yourself with all aspects of the framing and installation requirements.



Left hand and right hand is determined by viewing the doorway into which the door is to be fitted from the interior of the garage or room.



An overhead door imparts complex stresses to a building structure and requires correct framing techniques to avoid premature hardware failure. Do not attempt to install an overhead door directly onto a building's structural framework (studs). Do not install overhead door hardware onto drywall even if there is sufficient backing. The drywall will crumble under pressure, causing the hardware to loosen away from the wall.

TOOLS NEEDED

YOU WILL NEED THE FOLLOWING TOOLS TO PERFORM THIS INSTALLATION:











	TAPE MEASURE
	ELECTRIC DRILL AND BITS
	CARPENTER'S LEVEL
	STEP LADDER
	SAW HORSES (2)
	HACK SAW
	LOCKING PLIERS (2)
	HAMMER
	SCREWDRIVER
	WRENCHES
	WINDING BARS TWO 1/2" X 16' LONG COLD DRAWN STEEL RODS

FIGURE 1. FRAMING METHODS

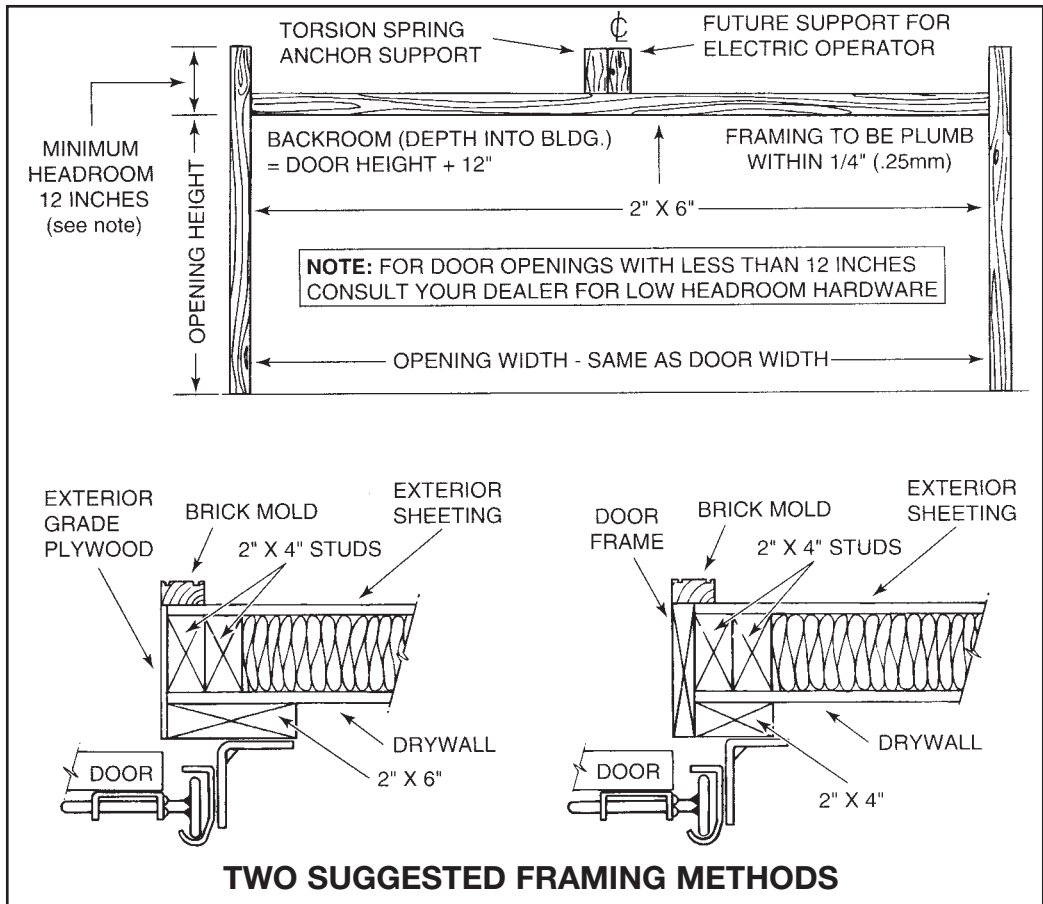

FIGURE 2. PREPARING BOTTOM SECTION

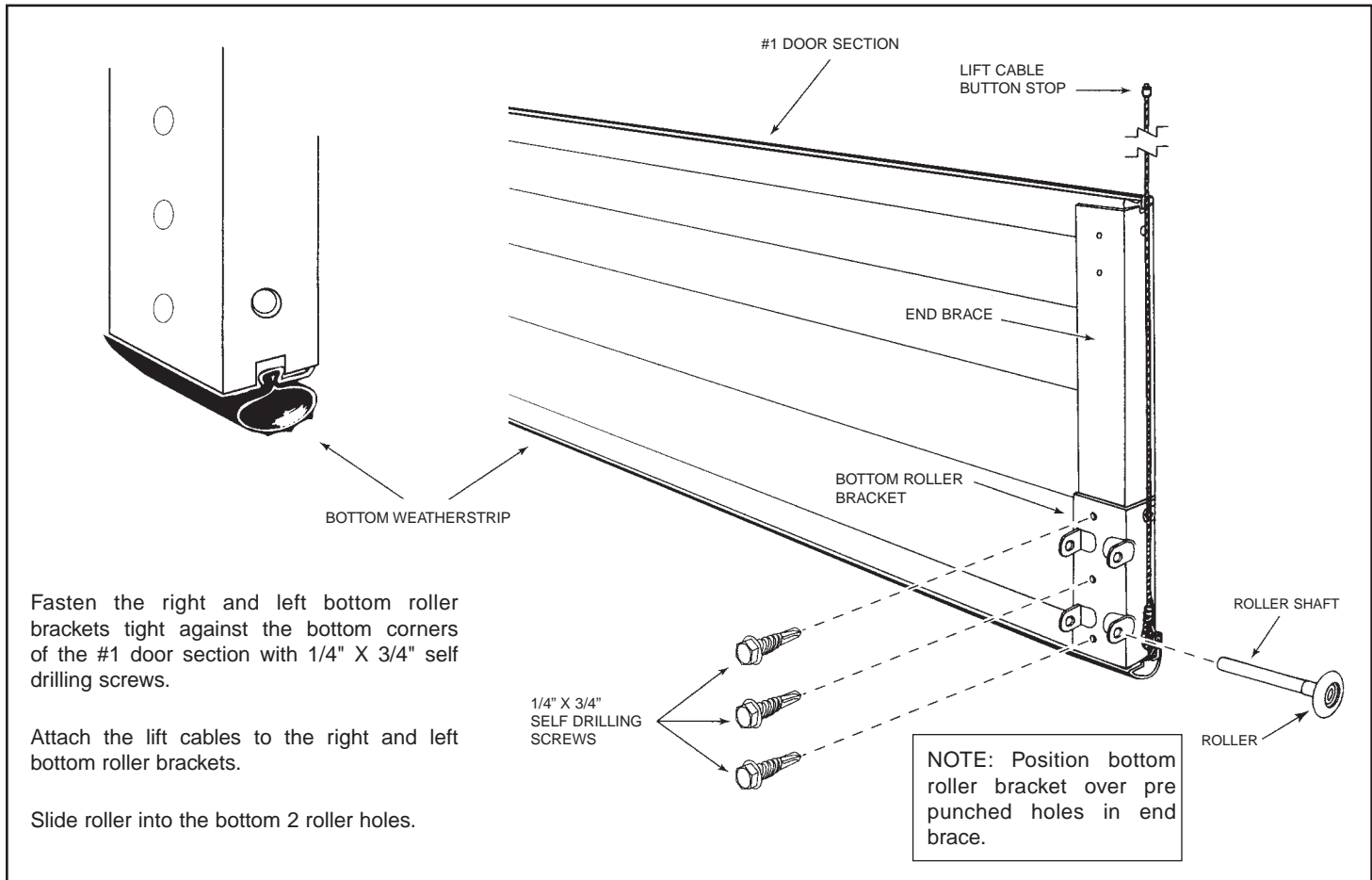
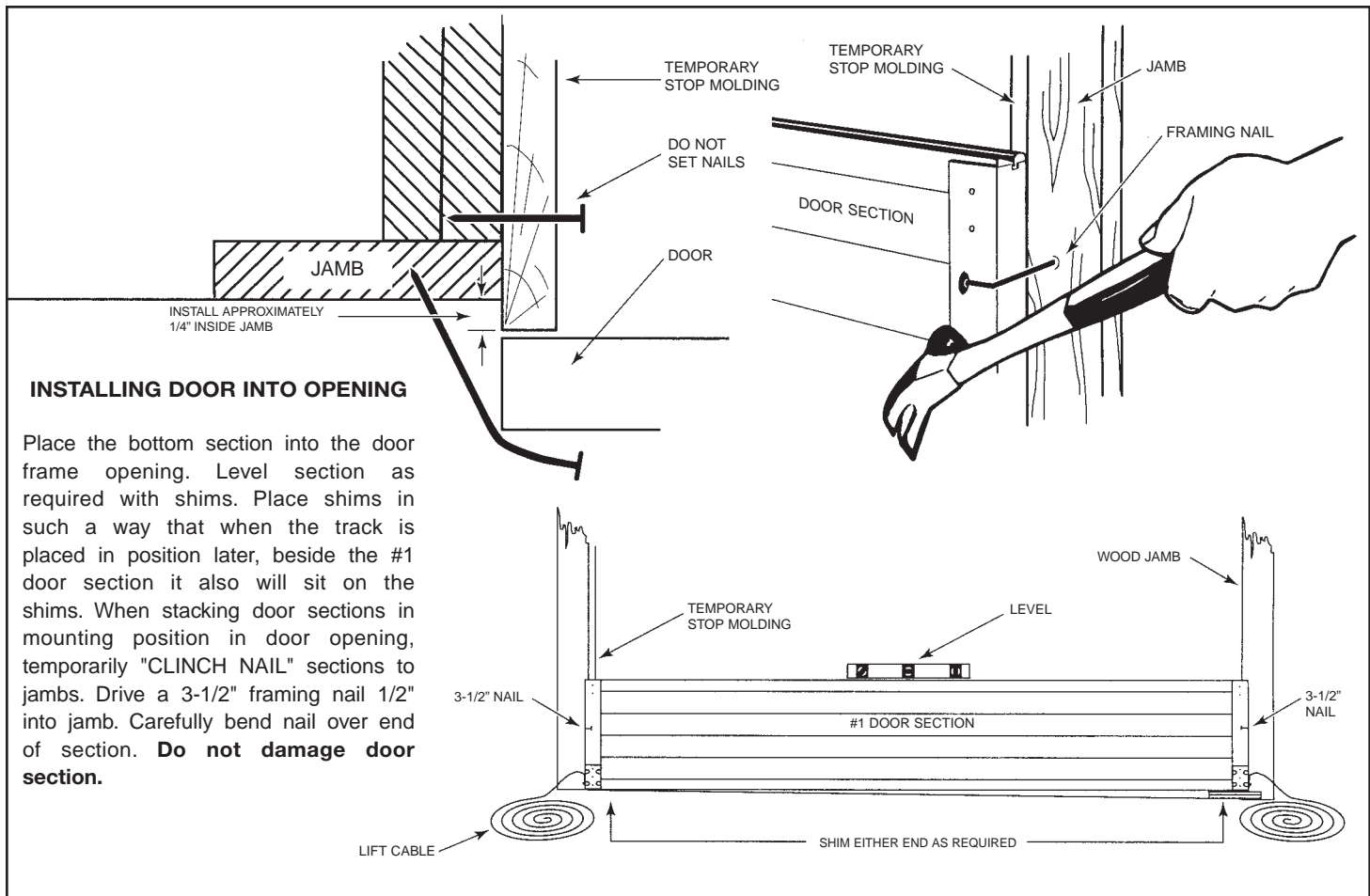

FIGURE 3. PLACING BOTTOM SECTION INTO OPENING



Page 4. PREPARING BOTTOM DOOR SECTION

FIGURE 4. PLACING DOOR INTO OPENING (8' door shown)

Note: Door sections are numbered 1,2,3,4 etc. on end brace.

Place the #2 door section on top of the #1 door section. Hold the #2 door section securely in place with two 3-1/2" nails as shown in Figure 3. Continue until all of the door sections are in place. If a door section has windows, decide placement in advance.

Note: Top of top section does not have a weather seal.

Note: 7' high doors are 4 sections high and 8' high doors are 5 sections high.

Mark centre hinge locations as shown at 2 intermediate locations equally spaced.

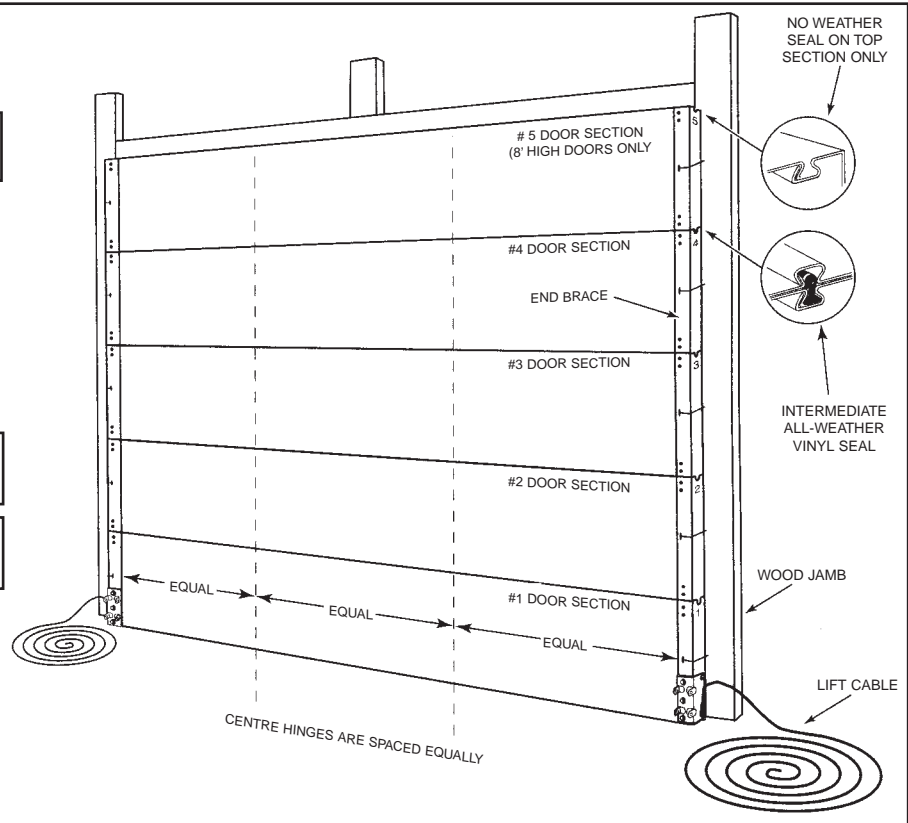

FIGURE 5. INSTALLING DOOR FACE HARDWARE (8' door shown)

Fasten all of the hinges to the stiles with 1/4" X 3/4" self drilling screws. The first roller hinges have a single pivot tube. The other outside roller hinges have two tubes (one is a pivot tube, the other is a roller tube for the roller shaft) and are marked #2 & #3. (8' high doors have #4 hinges). The #1 roller hinge fastens at the top of the #1 door section, above the bottom roller bracket. The #2 roller hinge fastens at the top of the #2 door section and so on. Position the top fixture 4" below the top of the door and secure with 4 - 1/4" X 3/4" self drilling screws.

Note: Position top fixture over prepunched holes in end brace approximately 4" from top.

Install rollers as shown. The **OPTIONAL** span brace fastens to the door with 2 span brace clips at each end as shown, just above the top fixture using 1/4" X 3/4" self drilling screws.
Caution:
Do not overtighten.

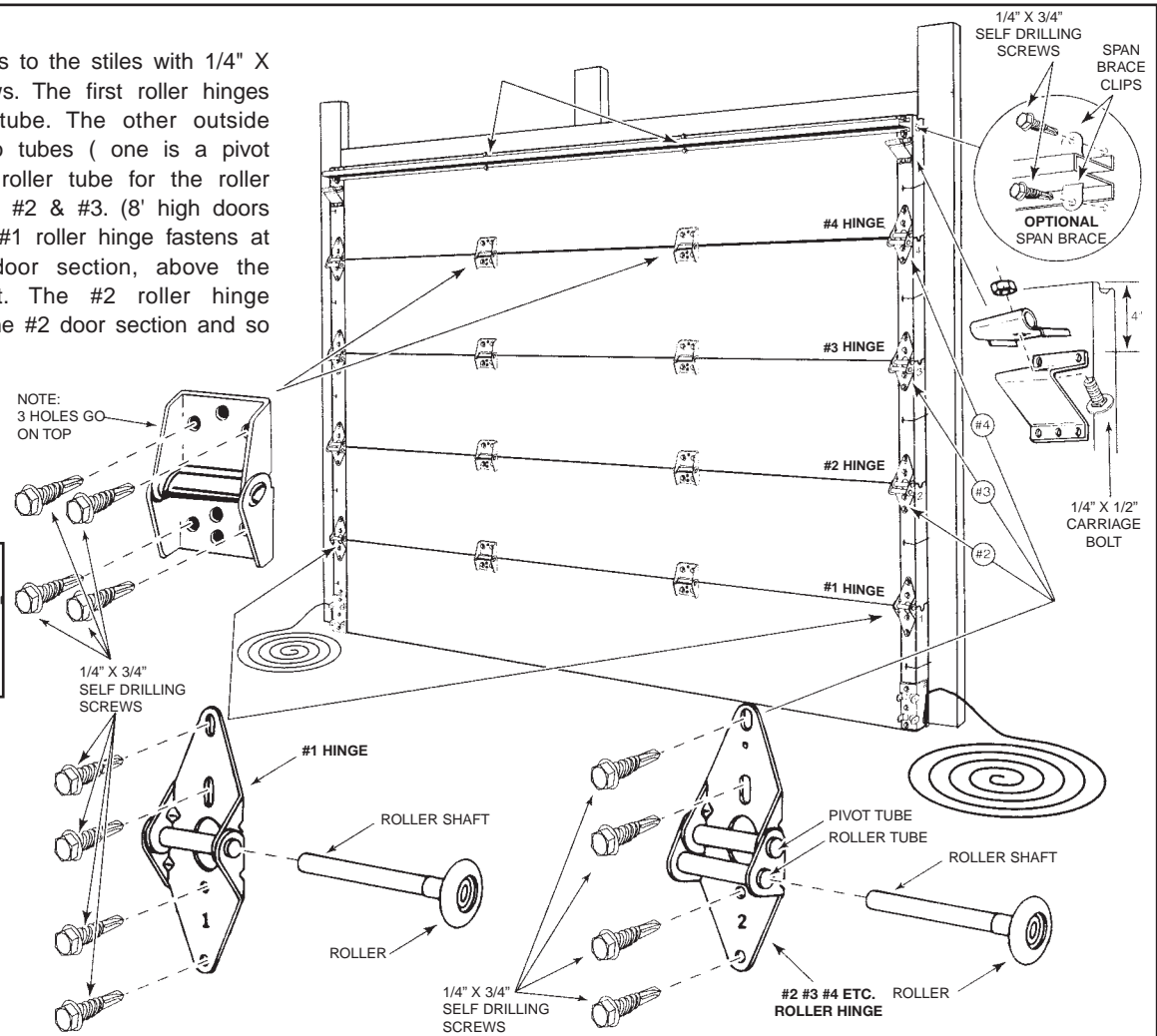

FIGURE 6. PREPARING TRACK

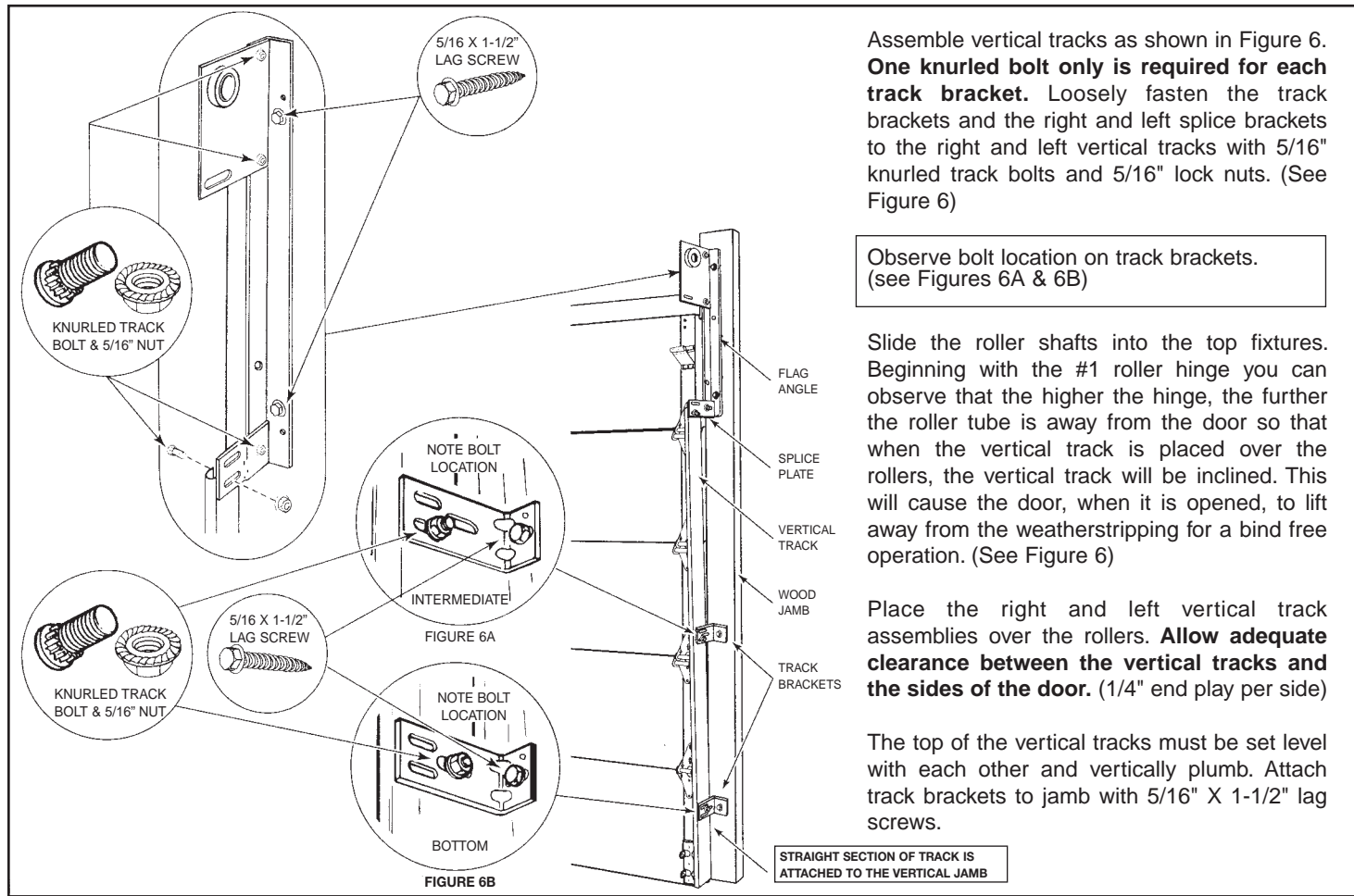

FIGURE 7. INSTALLING TRACK

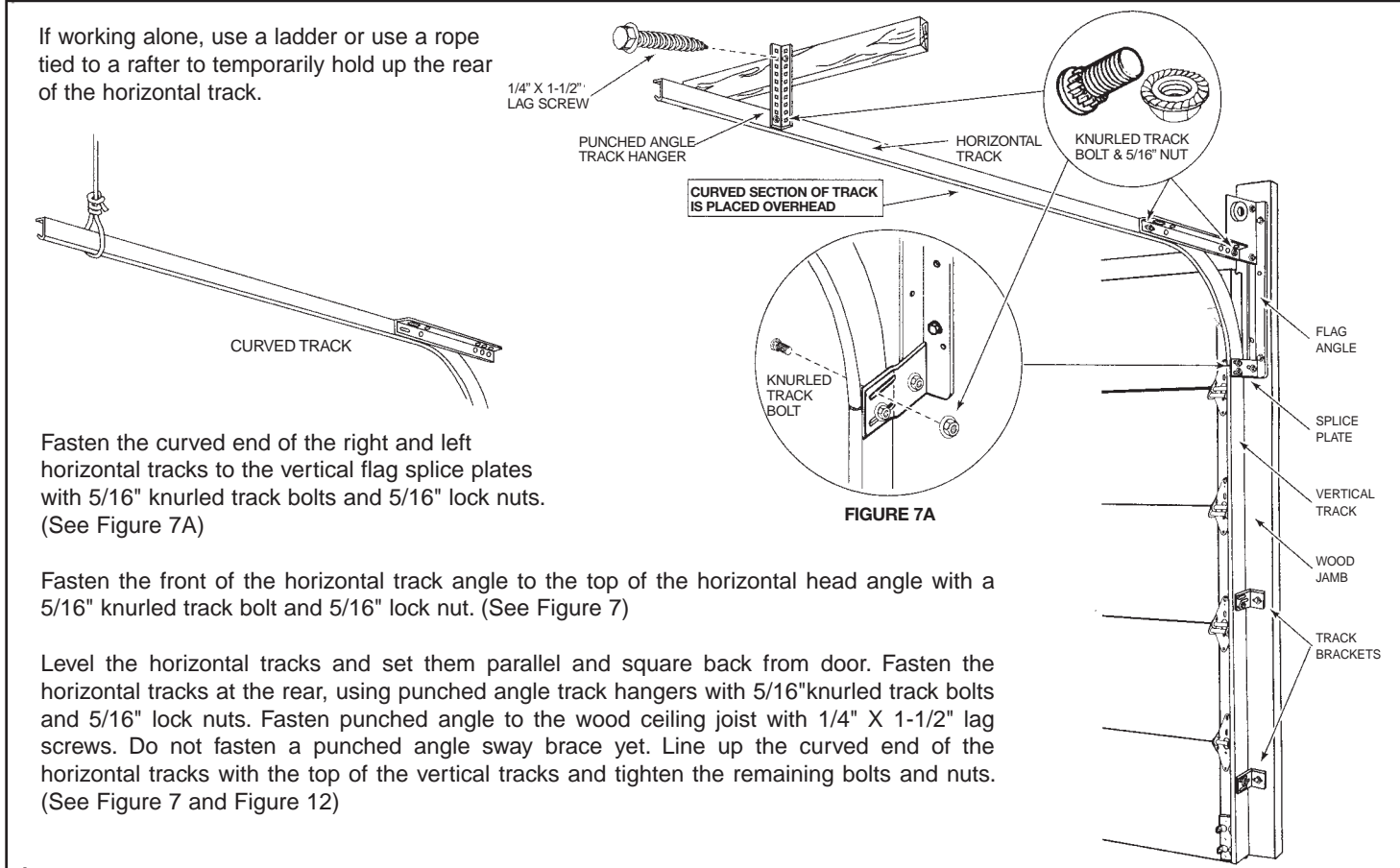
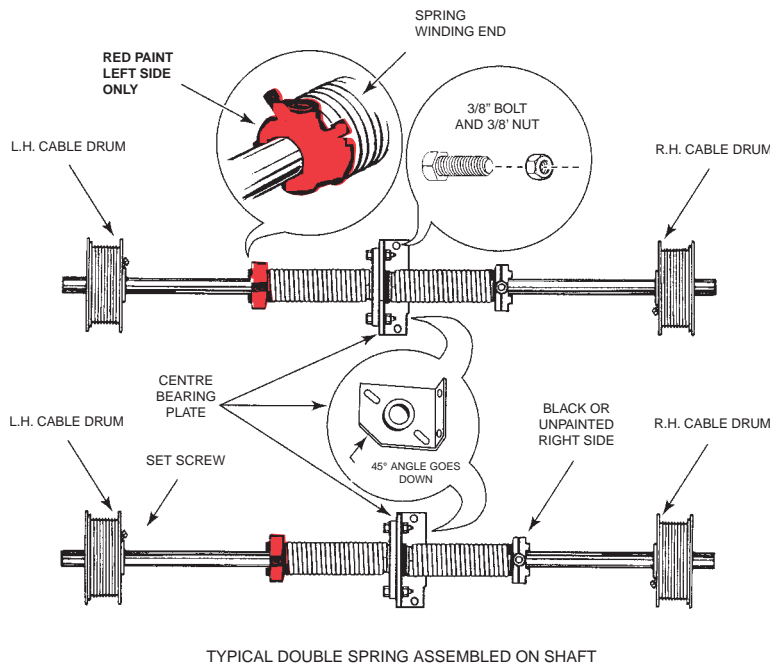

FIGURE 8. TORSION SPRING



Torsion springs are constructed from high carbon alloy steel and require careful handling. **DO NOT** drop or drag spring on a hard surface such as a concrete floor. Do not strike with a heavy or sharp object, or allow to come into contact with a welder's torch or stinger.



INSTALLING TORSION SPRINGS

Install spring assembly as shown.

Note: The most common error made is installing the torsion springs backwards. Carefully examine the spring ends. Red paint is on the L.H. spring winding end. A torsion spring wound the proper direction will get longer in length and smaller in diameter as it is wound. A torsion spring **IMPROPERLY** wound will get shorter in length and larger in diameter as it is wound.

OBSERVE THE **RED** UNPAINTED OR BLACK COLOR CODES ON THE SPRING WINDING CONES AND ASSEMBLE CORRECTLY. ALL REFERENCES TO RIGHT OR LEFT ARE VIEWED FROM INSIDE LOOKING OUT THROUGH THE DOOR OPENING.

Note: The torsion spring assembly will have red, unpainted or black spring winding cones. The red torsion spring will be assembled on the left side of the spring anchor bracket. If unpainted or black the torsion spring will be assembled on the right side of the spring anchor bracket. The left cable drum is assembled on the left side. The right cable drum is assembled on the right side. The 3/8" set screws must be installed in the cable drums and the spring winding cones. Do not tighten set screws.

Slide the torsion spring components together on the shaft and assemble as shown, using 3/8" X 1" bolts and 3/8" nuts.

FIGURE 9. INSTALLING TORSION ASSEMBLY

Lift the torsion spring assembly up and set it into position with the torsion tube inserted through the end bearing plates.



Anchor into a structurally sound member, if you have 1/2" drywall between anchor bracket and wood studs, replace with 1/2" plywood. If the spring anchor bracket is not securely fastened to a structurally sound wood member, the bracket can suddenly break loose and cause extreme bodily injury.

Fasten the spring anchor bracket securely to the wood spring pad with 5/16" X 1-1/2" lag screws at the correct height to keep the torsion tube level and straight.

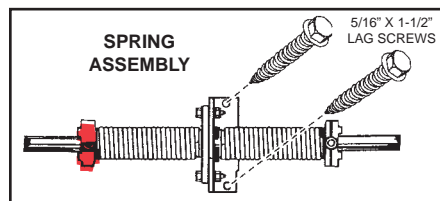

Installation tip: Look through the end of the shaft. When you can see a perfect circle at the other end, the shaft is perfectly straight. The shaft must be installed straight and level.

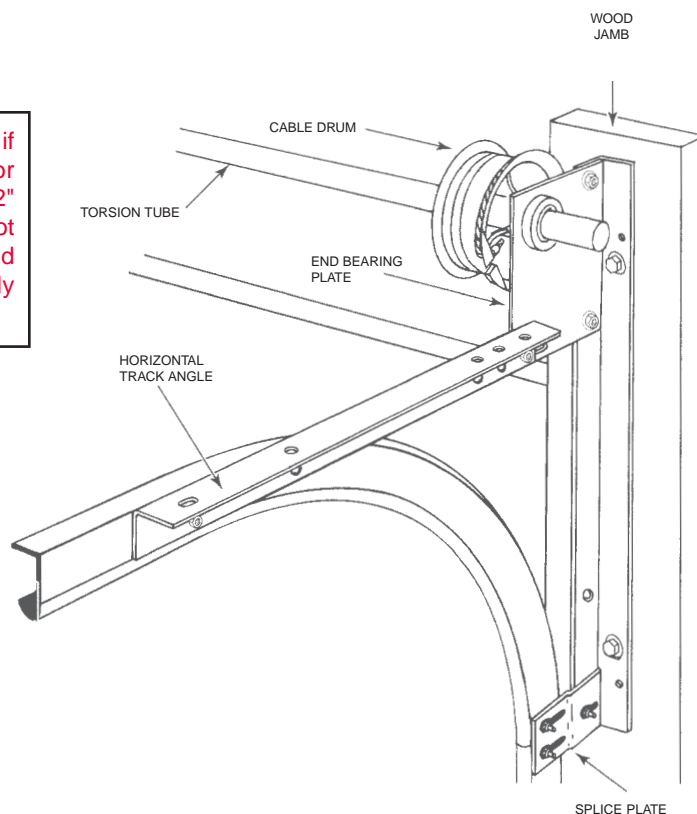

FIGURE 10. TORSION HANGING

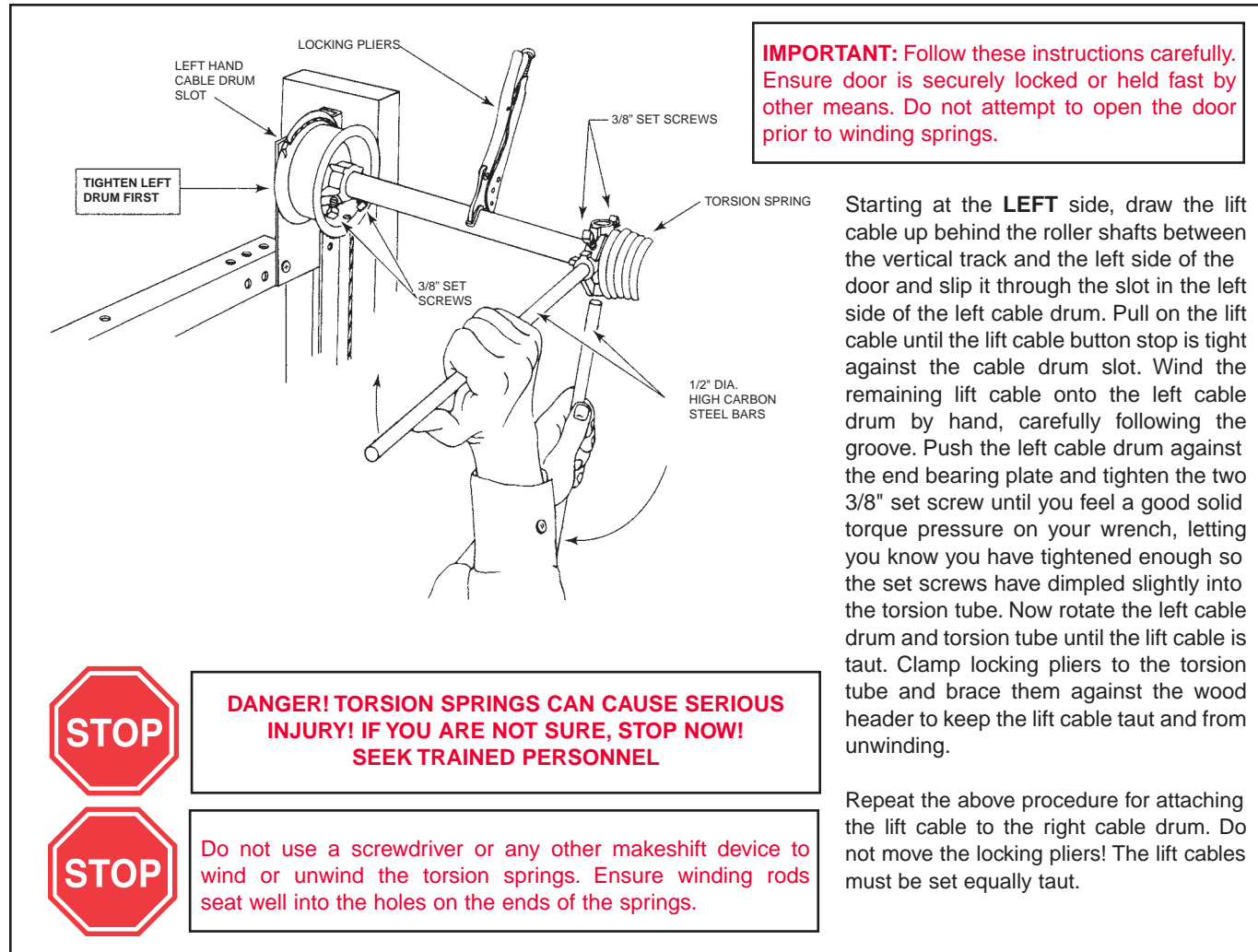

FIGURE 11. PREPARE FOR TRACK HANGING

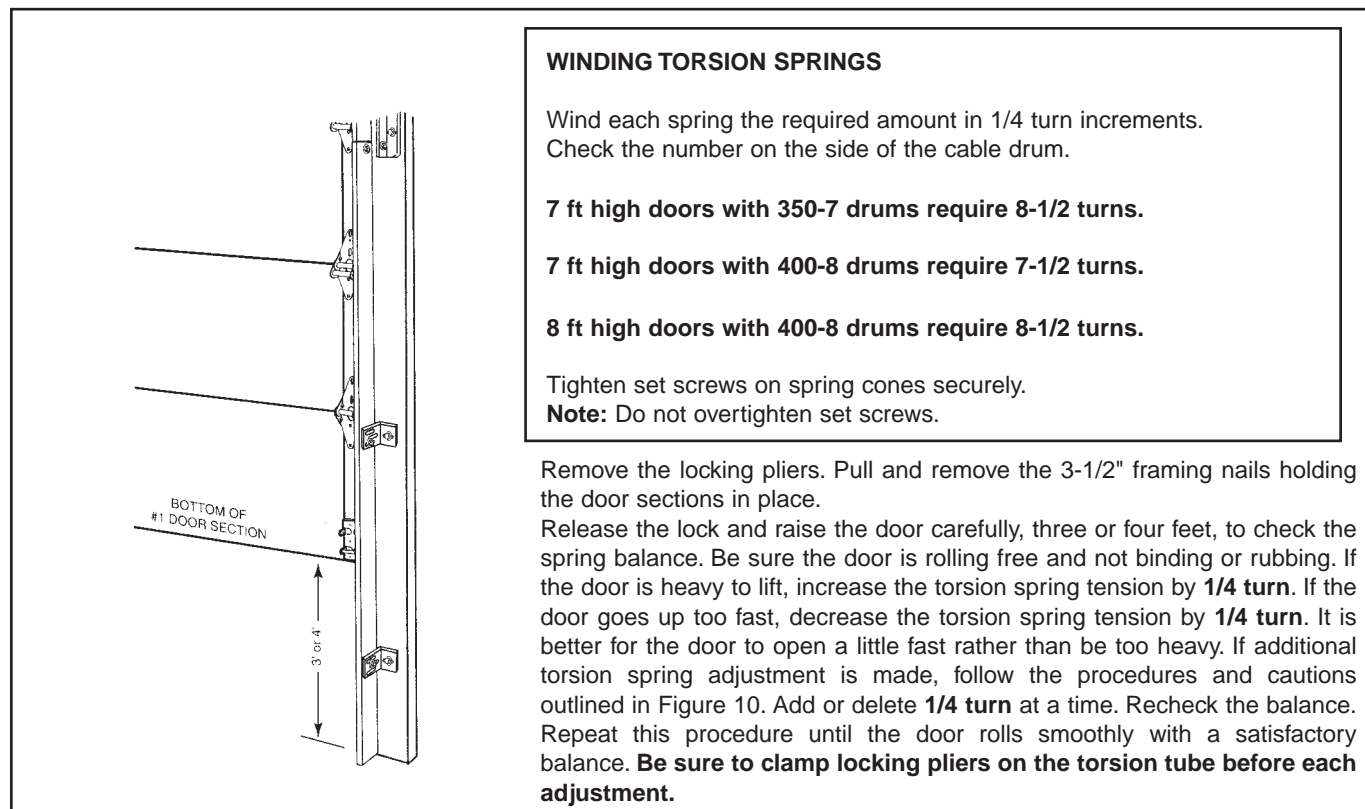

FIGURE 12. HORIZONTAL TRACK HANGING

Open the door all the way. Adjust the ends of the tracks. Install sway brace, allowing 1/4" minimum end play.



If horizontal tracks are set too far apart at rear, door may fall from tracks resulting in personal injury. Raise door slowly so that distance between tracks can be checked.

FOUR SUGGESTED TRACK HANGING METHODS

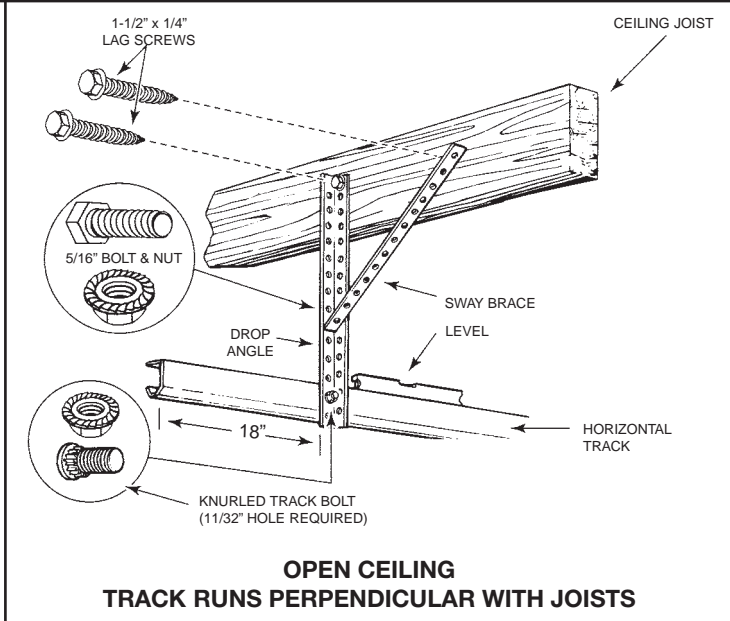
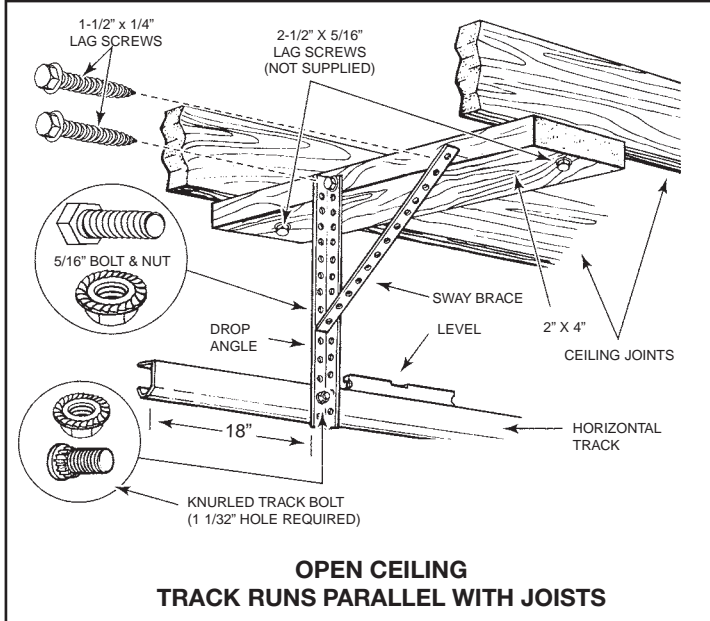
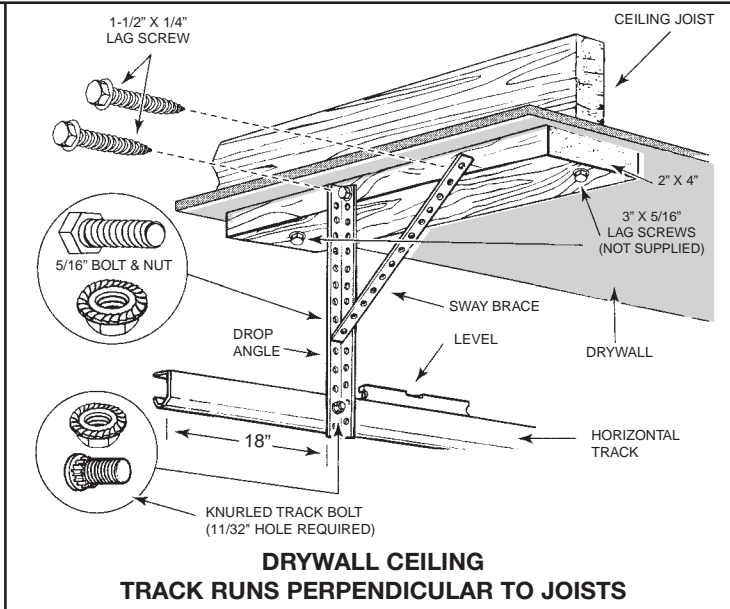
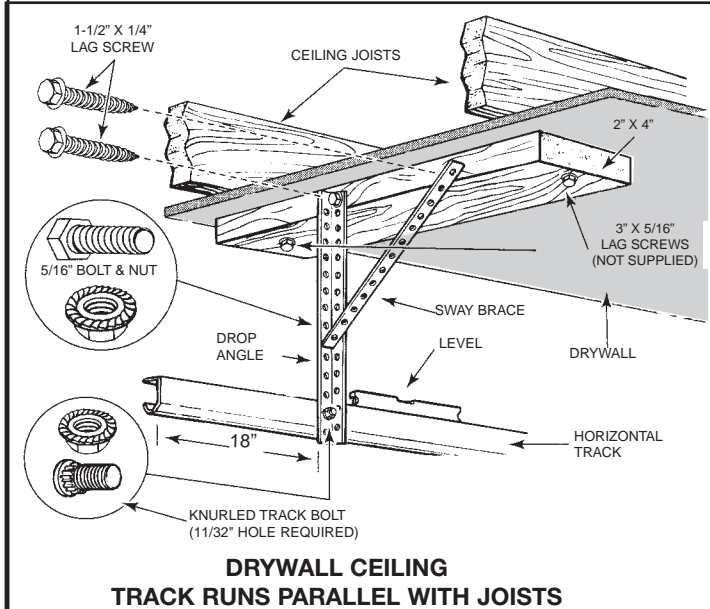

FINAL ADJUSTMENTS



Follow the safety guidelines and instruction from Page 8 and Figure 10

Fully open and close the door. Adjust the spring tension if required.

Note: After the door has been installed for a few days it may be necessary to add more tension, as the springs stabilize. Painting the door adds to the weight so more tension is needed after painting. Check all track spacing, track hanging, lock adjustment and tension. Adjust the top roller fixture so that the top section is vertically plumb.

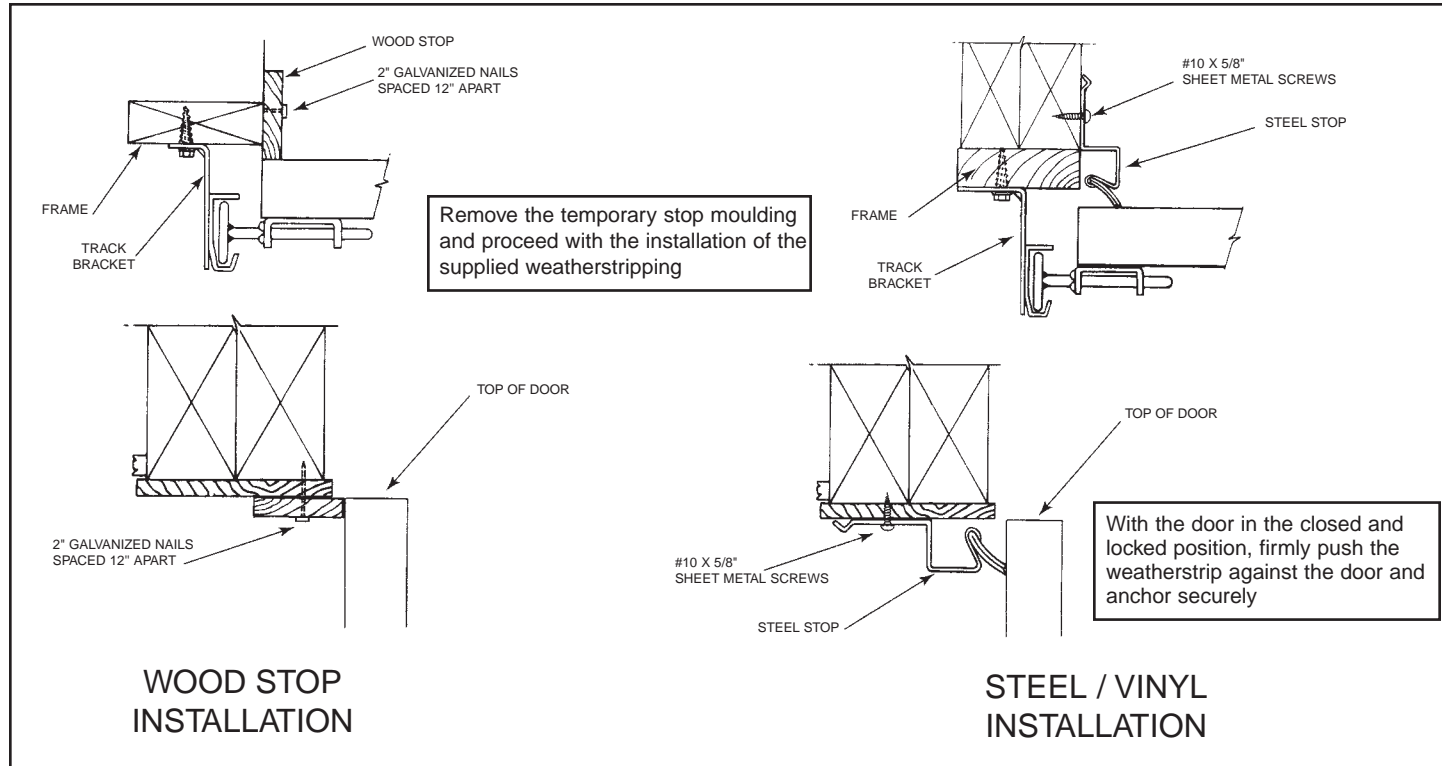
FIGURE 8. INSTALLING WEATHERSTRIP

PAINTING INSTRUCTIONS
FOR ALL FACTORY PRE-PAINT DOORS (T12, T16, TD134)

Your Steel-Craft garage door has a high quality baked on coating applied to it. No additional painting is needed. If you choose to paint the door, read these instructions thoroughly before proceeding.

1. Repair any bare metal areas to prevent rust. The paint surface must be roughened to accept a new coat of paint. Lightly sand the area with fine sand paper and wipe clean with a dry rag. Then paint the area with a high quality rust inhibiting primer.
NOTE: On doors with unpainted, galvanized stiles, if you chose to paint them, they will need to be cleaned with solvent such as Acetone, Xylon (Xylene) or M.E.K. (methyl ethyl ketone). Be sure to follow the label directions and safety guidelines when using solvents. Then use a primer meant for zinc coated or galvanized metals to coat the stiles. Follow the label directions and then paint with a desired top coat.
2. The garage door must be cleaned before painting, even if it doesn't appear dirty. Mix 1/4 cups of trisodium phosphate or laundry detergent (without softener additives) to one gallon of water. Wash and rinse the door thoroughly and let dry.
3. Check the paint for adequate adhesion. Regardless of paint brand, revisions in formulations or variations in the paint from batch to batch can affect performance. Follow the paint manufacturers directions, paint a small area and allow it to dry. Apply a strip of strapping tape or duct tape to the area and rub with a pencil eraser or thumb, leaving one end loose. Peel the tape off the test area. If no paint was removed, then continue with Step #5. If paint was removed, try another paint or prepare door as in Step #4.
4. Wipe down the door with a liquid deglosser such as E-Z paint deglosser, Savogram deglosser, or liquid Sandpaper. Be sure to follow the label instructions and safety guidelines precisely. Repeat Step #3.
5. Apply the coating according to the paint manufacturers directions paying particular attention to temperature limitations. Some manufacturers suggest to apply the paint with a sponge type brush.

*Steel-Craft Products Ltd. is not liable for marring or scratches which are beyond our control.
Steel-Craft will not assume any responsibility for the performance of the additional paint when applied to their garage doors.*

LIMITED WARRANTY

STEEL-CRAFT DOOR PRODUCTS LTD. (STEEL-CRAFT) warrants each garage door and component part to be free from defects in material and workmanship for a period of one year from date of delivery to the original purchaser. STEEL-CRAFT reserves the right to have authorized personnel inspect any part alleged to be defective and to refuse any returned material unless the return was previously authorized by STEEL-CRAFT. STEEL-CRAFT'S liability hereunder is limited to replacement of any part found to be defective. Labour charges are the responsibility of the customer.

STEEL-CRAFT SHALL NOT BE LIABLE FOR ANY CONSEQUENTIAL OR INCIDENTAL DAMAGES. ALL OTHER WARRANTIES, EXPRESSED OR IMPLIED, INCLUDING ANY IMPLIED WARRANTY OF MERCHANTABILITY ARE HEREBY EXPRESSLY EXCLUDED.

NOTE: MINOR SCRATCHES IN PAINT ARE NOT CONSIDERED DEFECTS.



Problem	Possible Cause
Door is heavy to lift or binds when first starting to lift.	Insufficient winds on spring. Spring installed backwards or wound backwards. Extra weight added to door. Stops installed too tightly. Springs compressed too tightly together.
Door lifts up by itself.	Too many winds on springs. Some hardware items left off door.
Door lifts off floor 1 or 2 inches and stays there.	Springs compressed too tightly together. Cable not located correctly on drum.
One cable loose when door is fully open or door lifts off level.	Door and track are not installed level. Horizontal tracks installed incorrectly. Cable length is wrong.
Spring plugs come out of springs.	Springs are being wound backwards.
Springs make clicking noise as door is raised.	Springs compressed too tightly together. Rust on or between spring coils.
Door raises normally to halfway, then speeds up rapidly as it opens fully.	Too many turns on springs which are too light for the weight of the door.
Door raises very quickly from the floor to halfway point but will not stay open.	Not enough turns on springs which are too strong for the weight of the door. CAUTION: Both cables could fall off drums and door could free fall if forced fully open.
Door makes grinding noise during opening and closing cycle.	Sand in rollers or headshaft bearings. Door off level and roller brackets rubbing on tracks. Track spacing wrong or off level.
Door opens part way. If forced further, cables come off drums.	Springs may be installed backwards. Recheck Figure 8.
Door bows inward in cold weather & outward in warm weather.	This is normal. All urethane injected doors bow when subjected to significant temperature differentials between the interior and exterior steel sheeting.

MAINTENANCE

1. Inspect the lifting cables. Check the cable anchoring at the bottom roller brackets to determine that the sleeve is tight and that the cable is in good condition. Check the cable through the entire length and ensure that the cable is properly secured at the drum. If the cables have become snagged, bent, or tangled, they should be replaced. The cables could appear to be in good condition, however, internal damage may have been done and fracture of the cable could follow. Use extreme care when working with the cables; relieve spring tension first.
2. All of the bearings located throughout the hardware should be lubricated. The rollers on the door, as well as the bearings on the headshaft, should be cleaned and lubricated with No. 30 motor oil.
3. All of the roller brackets, the centre hinges and the trusses should be checked for security. Tighten any loose fasteners and replace any hinges or roller brackets which are worn or fractured in any way.
4. Check the fastening of the guide assemblies and the hanging of the horizontal tracks. Make sure that all fasteners are secure.
5. Examine the torsion springs. If replacement springs are required, we recommend a qualified door Contractor be contacted.

SAFETY PRECAUTIONS

This door is constructed of high quality components to provide years of continued service. Since it is a large moving object, periodic maintenance along with the following cautionary directions should be observed to ensure safe and reliable operation.

1. Operate door only when it is properly adjusted and free of obstructions.
2. Door is constantly under extreme spring tension. Repairs and adjustments, especially to cables and spring assembly, can be hazardous and should be performed by qualified door service people only.
3. Do not permit children to play with garage door or electric controls.
4. If door is now, or later becomes electrically operated, pull down rope must be removed.
5. Avoid standing in open doorway or walking through doorway while electrically operated door is moving.
6. Should door become hard to operate or completely inoperative it is recommended that a qualified door contractor be contacted.
7. Keep fingers away from exterior of door while closing.

ACCESSORIES:

Steel-Craft offers many optional accessories for your garage door. See below.

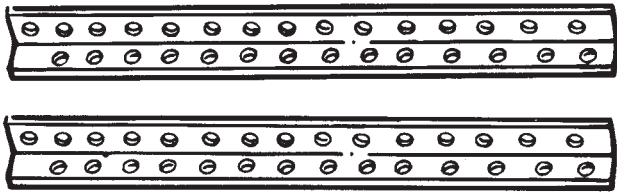

**PREPUNCHED
HANGING ANGLE**

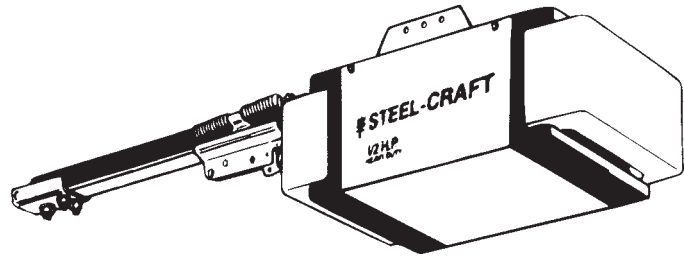

GARAGE DOOR OPENER

**VARIOUS LOW HEADROOM
PRODUCTS**

(Contact your authorized dealer)

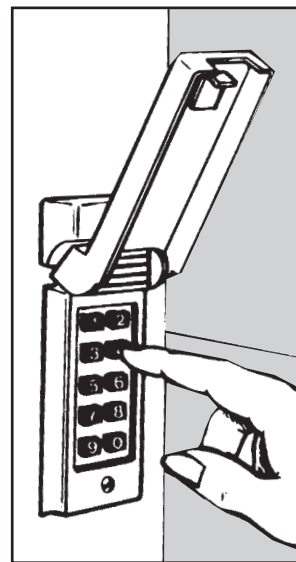

**DIGITAL KEYLESS
ENTRY SYSTEM.**

Opens, closes garage door from the outside without transmitter or keys.

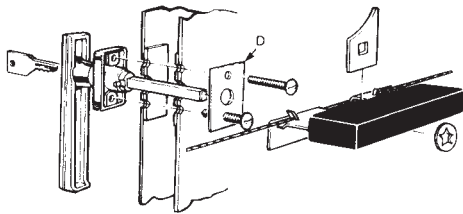

LOCKING SYSTEM

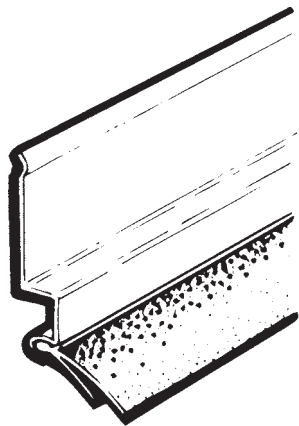

FULL PERIMETER WEATHERSTRIPPING



WINDING RODS (7/16" x 16" LONG)
(Available at Steel-Craft Door Products Ltd. or authorized dealers)

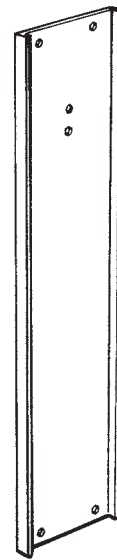

OPERATOR PLATE
RECOMMENDED ON DOORS WHEN
INSTALLING A GARAGE DOOR OPENER